

# USER'S MANUAL



Serial Number: \_\_\_\_\_

Voltage: \_\_\_\_\_



## **Safety Issues**

- When installing the D400, exercise due care at all times. The turbine weighs 15 kilograms and is awkward in shape. It is best to plan the installation carefully in advance and enlist some help when erecting the machine in order to avoid accidents.
- Complete as much of the installation procedure as possible at ground level.
- Choose a calm, dry day for your installation if possible.
- D400 blades are quite sharp, particularly on their trailing edges. Handle with care.
- D400 is robustly engineered, but contains high-energy ferrite magnets that can be damaged if the machine is dropped or handled heavily.
- When running, particularly if disconnected from the batteries, D400 is capable of producing high voltages. Caution must be exercised at all times to avoid electric shocks.
- Always observe correct polarity when connecting D400 to an electrical circuit. Reverse polarity connection will result in damage to the wind generator.
- The D400 must be appropriately fused at all times.
- Never approach the path of the blades when the machine is operating as severe personal injury could result.
- Always stop the machine and secure the blades before attempting maintenance.
- Ensure that all batteries are disconnected when undertaking maintenance.

## Contents

Safety issues	1
Introduction	2
Features of the D400	3
Dimensions	4
Output	4
Checklist (parts, tools etc)	5
Principles of wind energy	5
Installation - Boats	6
Terrestrial mounting	7
Guyed towers	7
Freestanding towers	8
Roof mounting	8
Assembling the D400	9/10
Electrical connections	11
Fusing, Stop switch	11
Regulation	12
Electrical installation/ Circuit diagrams	13/14
Performance and expectation	15
Routine maintenance	16
CE Conformity	17
Guarantee	17

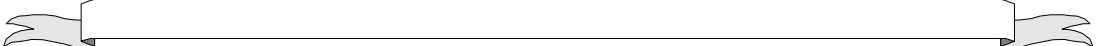

**Thank you for purchasing the D400 Wind Generator,**  
designed and manufactured by Eclectic Energy Limited.  
The D400 is one of the most efficient, powerful and well-engineered  
turbines currently available. It is important, however, that you  
thoroughly read the entire manual prior to installation to ensure  
optimum safety and performance of the equipment.  
Should you be left with any questions or uncertainties, having read  
the manual, please contact your authorised dealer or Eclectic  
Energy Ltd direct for further clarification.

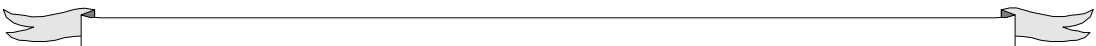

## Features of the D400

The D400 has been developed specifically to operate in close proximity to people. The noise and vibration usually associated with small wind turbines has been designed out of the D400. This has been achieved by making the turbine run relatively slowly for a given electrical output. In a given wind speed and a given electrical output, the D400 rotates at less than one quarter the speed of some competitor units. Combined with its rugged engineering and advanced computer-designed air blades, this makes the D400 the most reliable and benign turbine of its class currently available.

The air blades are precision injection-moulded from glass reinforced nylon and as well as featuring taper and twist incorporate a special low-Reynolds airfoil section which varies continually in camber from tip to root. Because of the production method used, the blades are extremely consistent in terms of mass and can be replaced singly should damage occur without losing turbine balance. The alternator and yaw shafts are precision-ground from 316 grade stainless steel, and the D400's body is a robust aluminium alloy casting.

The bearings are high quality and generously sized, and are protected by twin-lipped radial shaft seals.

The tail is formed from aluminium sheet into a shallow 'S' section in order to impart stiffness and prevent resonance. All aluminium parts are etched, alachromed and finished in a tough polyester powder coat.

The D400 utilises a 12-pole, 3-phase axial field alternator of very high efficiency. It comprises two large annular magnet rotors with stator coils positioned in between. The stator coils themselves are wound from heavy gauge copper and are encapsulated in a heat-inductive resin. This in turn is bolted to a machined shelf within the aluminium housing, so ensuring excellent heat dissipation from the machine. A combination of the advanced air blade and alternator design delivers unparalleled efficiency in low wind speeds together with the ability to produce sustained high outputs in high winds.

Eclectic Energy Ltd's attention to design and quality should ensure your D400 gives years of trouble-free service.

Congratulations on your purchase.



# Dimensions, output



Rated Output 400 W at 32 knots (16 m/s)

## D400 Wind Generator Output

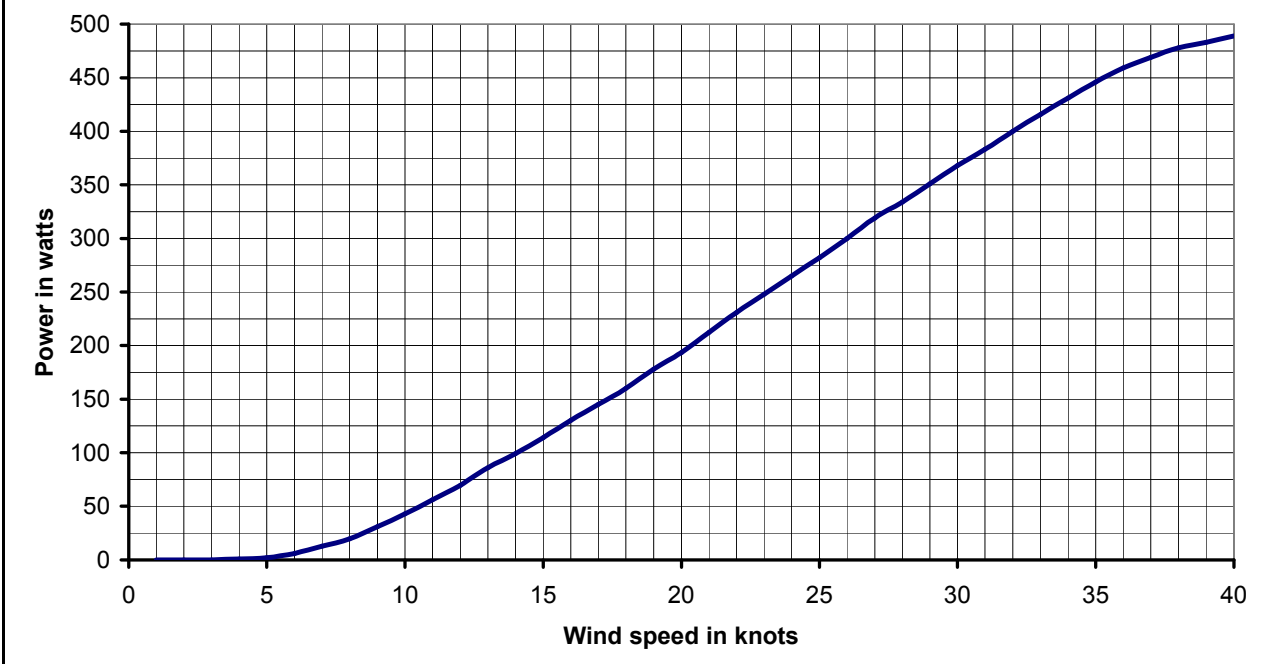

## Checklist

*Check that you have received in your delivery two cartons containing:*

1 x alternator body  
5 x air blades  
1 x tail  
2 x hub plates  
1 x tower sleeve  
1 x air hub spacer  
Fasteners

*Required for installation:*

Mounting Tower  
Extension cable  
Batteries  
Battery terminals  
Connection blocks  
Cable clips  
Etc

*Additional system items:*

Regulator  
Charge splitters  
Volt and ammeters

*Tools:*

Spanners  
Screwdriver  
Wire strippers  
Etc

### **The principles of Wind Energy**

Wind is a function of solar energy unevenly heating the Earth's surface. As warmer air rises at the equator, cooler air flows in to replace it, setting in train global convective currents. This circulation which we call wind distributes both heat and moisture more evenly around the earth so providing us with a comfortable planet to inhabit.

The same process of convection also happens more locally, for example differential heating producing the summer land and sea breezes. These streams of moving air also provide us with an inexhaustible, if intermittent, energy source.

A wind generator works by converting some of the kinetic energy in wind stream to electricity. Air weighs about 1.2 kg per cubic metre at sea level, and kinetic energy is expressed by mass times the square of its velocity. Understanding this is a key to appreciating the energy available to wind generators.

In short, the amount of energy available to the wind generator rises dramatically with increasing wind speed. Regrettably, the reverse is also true. In low wind speeds there is very little energy to capture.

It is important, therefore, when considering the site of your wind turbine, that you choose a site with the highest possible wind speeds. In addition, the airflow should be as free from turbulence as possible.

# Installation

## Site Selection

When **mounting on a yacht or boat**, positioning the turbine will be influenced by the configuration of the boat and other equipment fitted. It is important to ensure that the blades are at sufficient height such that injury to the crew from rotating blades is unlikely. A minimum height of the lowest point of the airblades above a crewed area should be 2.4 metres.

Also ensure that no part of the turbine can come into contact with any other part of the boat's fittings or rigging. Because the turbine is subject to dynamic loads when the yacht is in a seaway in addition to wind loads, the tower should be securely braced or guyed both fore and aft and athwartships. The bracing struts or wires should be firmly attached to the main tower at a point 200 –300 mm below the lowest point of the blades.

The D400 is an inherently quiet and low vibration machine. However, certain applications may benefit from the introduction of anti-vibration mounts under the main tower and bracing struts. Note that no unsupported tower should exceed 2 metres in length. The wind loading on the D400's rotor disc can exceed 50 kg, so any tower structure should be capable of withstanding at least this load in a horizontal direction at the height of the turbine.

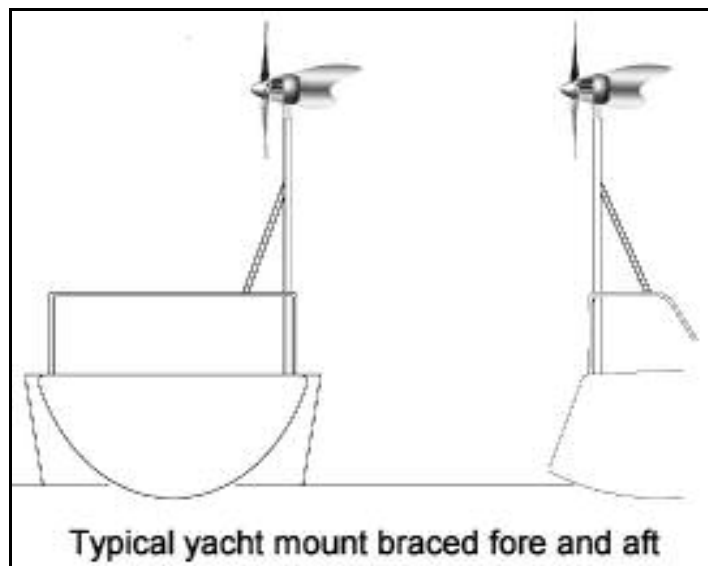

For inland watercraft such as narrow boats, a hinge-down tower arrangement can be utilised to allow for rapid lowering of the turbine for passage under low bridges etc.

For ketches and yawls, a mizzen mount is often suitable.

The D400 is also suitable for mounting on stern arches and targas.  
Contact your Dealer or Eclectic energy Limited for further information.

## Terrestrial Mounting

The performance of your D400 will be influenced by the topography of your proposed mounting site. In any location, the nearer the surface of the Earth, the lower the prevailing wind speed. This is a result of friction between the air stream and obstacles on the surface of the Earth. Such turbulence will reduce the efficiency of any wind turbine. It is important, therefore, to locate the D400 in the clearest airflow possible.

Aim to mount your D400 at least 8 metres above the height of any surrounding obstruction within a 100 metre radius. If this is impractical, aim to mount the turbine as high as possible.

A useful assessment of the quality of airflow at a proposed location can be achieved by attaching a streamer, similar to a kite's tail, to a pole and letting it fly at the proposed height of the turbine. If the streamer flies straight, the airflow is clear. If the streamer flutters and spirals, turbulence is present, and you should consider an alternative site.

Mounting towers can be either guyed or free-standing. Free-standing towers need to be very substantial and are therefore generally expensive. Guyed towers are the more usual choice.

## Guyed Towers

A typical guyed terrestrial mount for a D400 would consist of a tubular tower supported by four or more guy wires. No more than 2 metres of the tower should extend above the upper guy wire attachment point. The guy wires themselves should be of at least 4 mm in diameter with a breaking strain in excess of 50 kg. They should be galvanised or stainless steel for protection against the weather. Shackles and bottle screws should be at least 5 mm in diameter and where guy lines are looped, the loop should be held with a minimum of 3 wire rope grips, and should incorporate a thimble to form the eye.

Guy wire radiuses should be observed. The recommended radius for the guy wire anchors is 0.6 of the tower height.

Four guy wires are preferable to three, as this enables the tower to be hinged up from its base with three guy wires already in place to support the tower as it ascends.

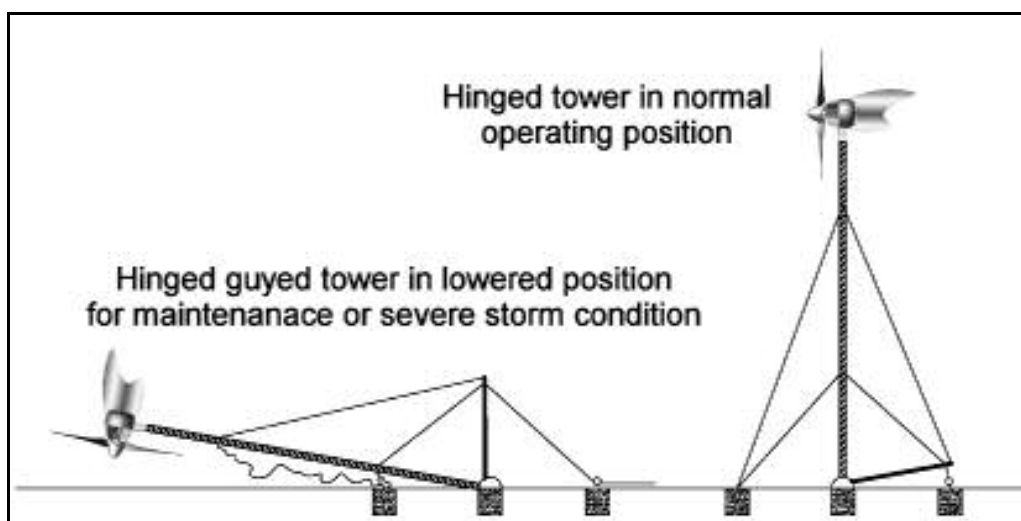

Minimum blade to tower clearance

130mm

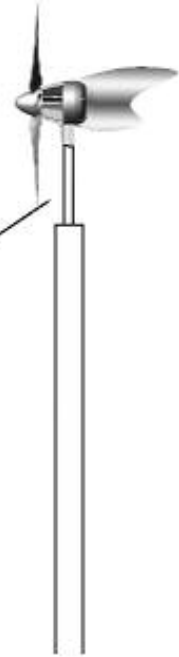

### Freestanding Towers

For small wind turbines such as the D400, free-standing towers can take the form of old telegraph poles, or a self-supporting steel lattice tower.

It is important to ensure the tower's foundation is sufficient such that the tower will withstand a horizontal load of 70 kg at the height of the turbine.

In order to ensure that an acceptable blade to tower clearance is maintained, a stub tower should be used between the D400 and the free-standing tower. See illustration.



### Roof Mounting

Due to its quiet, vibration-free operation, the D400 is particularly suitable for rooftop mounting.

Mounting on buildings has the advantage of achieving additional height. There is also often a localised increase in wind speed due to the compression effect of wind flowing over the ridge of the roof. This is particularly true when the prevailing wind is at 90 ° to the roofline. Generally speaking, a mount height of 1.5 to 2.5 metres above the ridge line will place the turbine in the best air flow.

It is important that the building structure and the mounting bracket attachment is sufficiently strong to support the turbine adequately in all wind conditions. Despite D400's quiet, low vibration operation, the installation may benefit from additional, anti-vibration mountings to prevent the transmission of vibration into the building structure.

## Assembling the D400

Your D400 is supplied in two cartons. Unpack these and check the parts against the list at the beginning of this manual.

- Assemble the air rotor by sliding together the keys and mortises at the hub of the five air blades.
- Take the white, powder-coated hub plate, pass two 5mm bolts and washers through the inner holes, and fit the rotor hub spacer over the 5mm bolt heads, such that the shaft securing hole, which passes through the rotor hub spacer, faces forward.
- With the body of the wind generator on its back, offer the hub assembly up, and slide it onto the alternator shaft.
- Align hole in rotor spacer with 6mm tapped hole in alternator shaft and secure with 6mm cap screw provided. Tighten firmly.



- Offer rotor blade assembly up to rotor hub spacer and slide into place.
- Ensure that the rotor assembly is fitted the right way round. The annular groove on the blade roots should face the rear (tail end) of the machine, and the face with the 10 conical holes in the blade roots should face forwards.
- Fit outer stainless steel hub plate, place nuts and washers on inner 5mm bolts and tighten gently.



- Rotate air rotor in relation to hub until the five blade securing holes align.
- Pass a 5mm bolt through the inner powder-coated plate such that it passes right through the rotor blade and outer hub plate, fitting a washer and nut each time.



- Finally, evenly tighten all fasteners.
- Note that the rotor should only be secured using new nyloc nuts.*



## Assembling the D400 (continued)

- Place the turbine face down on its rotor, and attach the tail using the three M6 nuts and bolts provided. Note that the tail should be fitted to the left-hand face of the casting flange when the D400 is viewed from the rear. The large stainless steel washers should also be fitted on the left-hand side.



- To fit the rotor spinner, offer up the axial splits in the moulding to the leading edges of the blades while holding the spinner square and central over the hub. Gently open each of the axial splits, and encourage it to pass over the leading edge of the blades.

- Finally, rotate the spinner anti-clockwise such that it effectively screws onto the blade roots. Snap the rear edge of the blades slot behind the trailing edge of the five blades (see pictures).



- Remove the tower spacer from the D400's yaw shaft, and check it for fit with the proposed mounting tower. It is far preferable to discover it does not fit at this juncture rather than when you are actually attempting installation. The standard tower liner has an outside diameter of 41 mm and is designed to slide into standard aluminium or steel scaffolding tubing with a nominal outside diameter of 48mm and inside diameter of 41.5mm.

*Should the tower liner not fit the tower tube correctly, consider sourcing an alternative mount tower or contact your supplier to order an alternative tower liner. On no account attempt an installation where the tower liner is a 'sloppy' fit in the tower, as this will lead to instability when the machine is operating, and could lead to machine damage.*

- The tower liner is retained to the yaw shaft by a single grub screw. Once the machine has been installed, the tower liner should be secured by drilling two holes through the top of the tower into the tower liner to a depth of 12mm with a 4mm drill, finally securing with two 8x12mm self-tapping screws.

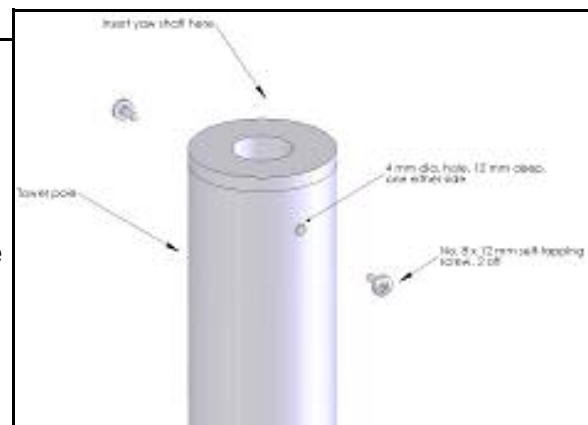

**Your D400 is now ready for installation**

## Electrical Connections

Connecting cables between D400 and the battery bank or inverter should be appropriately sized to minimise transmission losses. For low voltage machines transmission losses are always a consideration, so it is advisable to keep cable runs as short as possible and be prepared to use heavier gauge cable for longer runs.

Typically, you should use cable of at least 4.5 square mm conductor cross section (AWG 11). For longer runs approaching 30 metres you should consider 17 square mm cable (AWG 5) for the 12 volt D400.

Note that the transmission losses associated with the 24 volt machine are lower, and 6 square mm (AWG 10) would suffice for a 30 metre run.

Where D400 is fitted to a tall mounting tower, ensure the weight of the hanging cable is taken by a strain relieve arrangement within the tower, rather than simply hanging on the D400 cable connection.

### Fusing:

D400 is capable of producing very high currents. A line fuse must always be installed in order to protect the D400.

A blade-type 50 amp rated fuse and holder is supplied with 12 volt machines.

A blade-type 30 amp rated fuse and holder is supplied with 24 volt machines.

Note: where a stop switch is fitted, the fuse should be installed between the switch and the batteries.

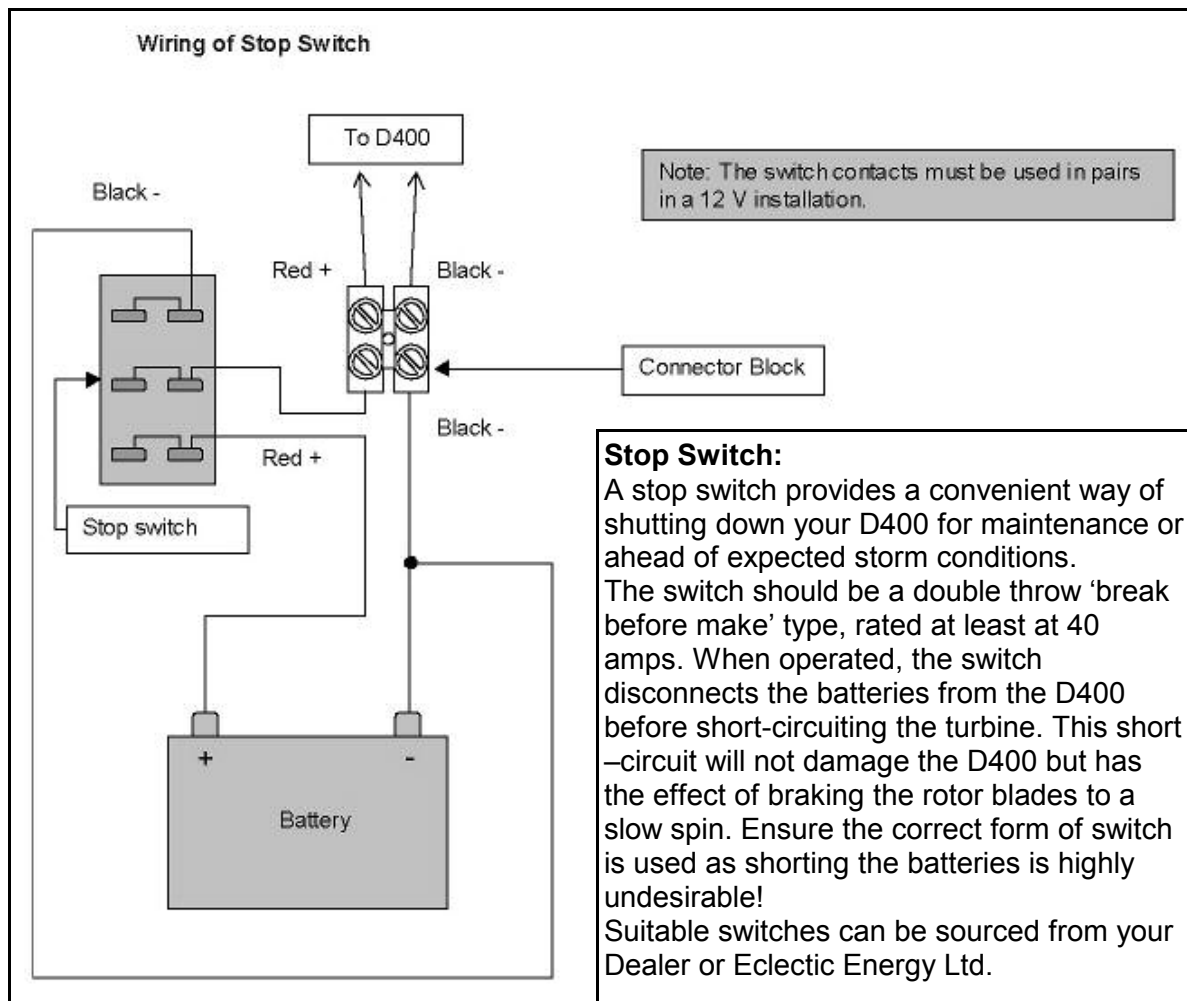

## **Regulation**

Where D400 is being used for battery charging we strongly recommend that a regulator is installed as part of the system. The regulator's function is to prevent battery damage through overcharging. The regulator works by sensing battery terminal voltage and as a pre-set upper limit is approached, the regulator progressively dumps output from D400 to a pair of large, foil-wound resistors, where the surplus energy is lost as heat.

The regulator unit supplied by the manufacturer incorporates a charge splitter so its output can be connected to two independent battery banks simultaneously. It will preferentially charge the lower of the two banks first. The unit will also accept the output from up to 100 watts of solar panel.

The regulator should be installed within 1 metre of the battery bank and the dump resistors mounted horizontally in an area where air is free to pass over them for cooling.

**See wiring diagrams on next two pages.**

# Electrical Installation

## Single battery bank installation



It is recommended that the D400 is hard wired to the battery system.

In yacht installations, the cable should enter the yacht via a cable gland. Deck plugs and sockets should not be used.

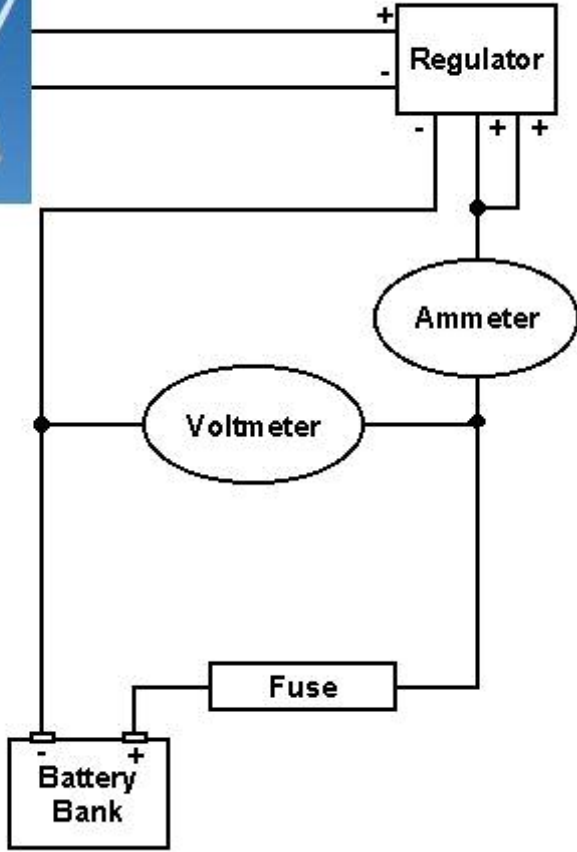

**The D400 must always be connected to a battery when in use, otherwise a dangerously high voltage can be generated at the output cable.**



## Unregulated installation

If in doubt, refer to a competent electrical engineer or the manufacturers.

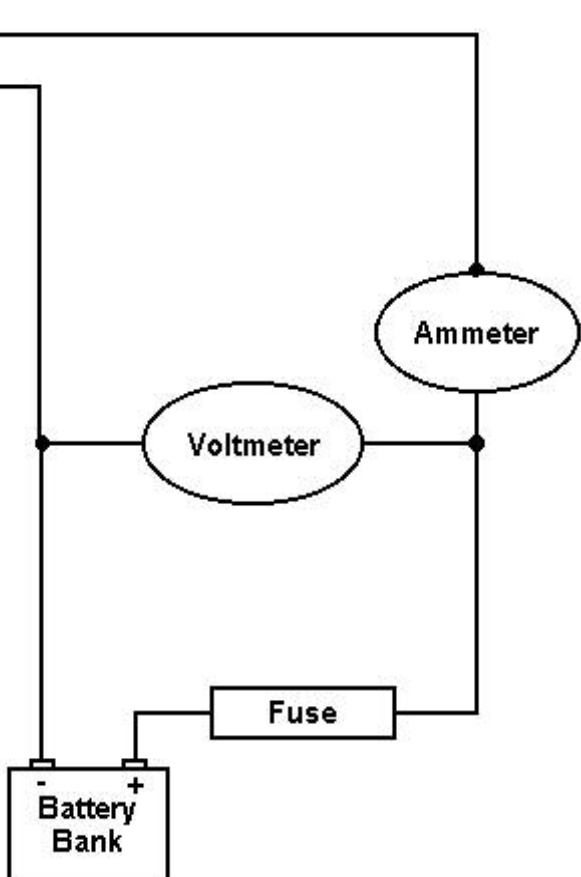

# Electrical Installation

Connect the output cable to the battery bank(s) using the suggested wiring diagrams for guidance. Remember to observe the correct polarity.

RED to POSITIVE + and BLACK to NEGATIVE –

## Twin Battery Bank Installation

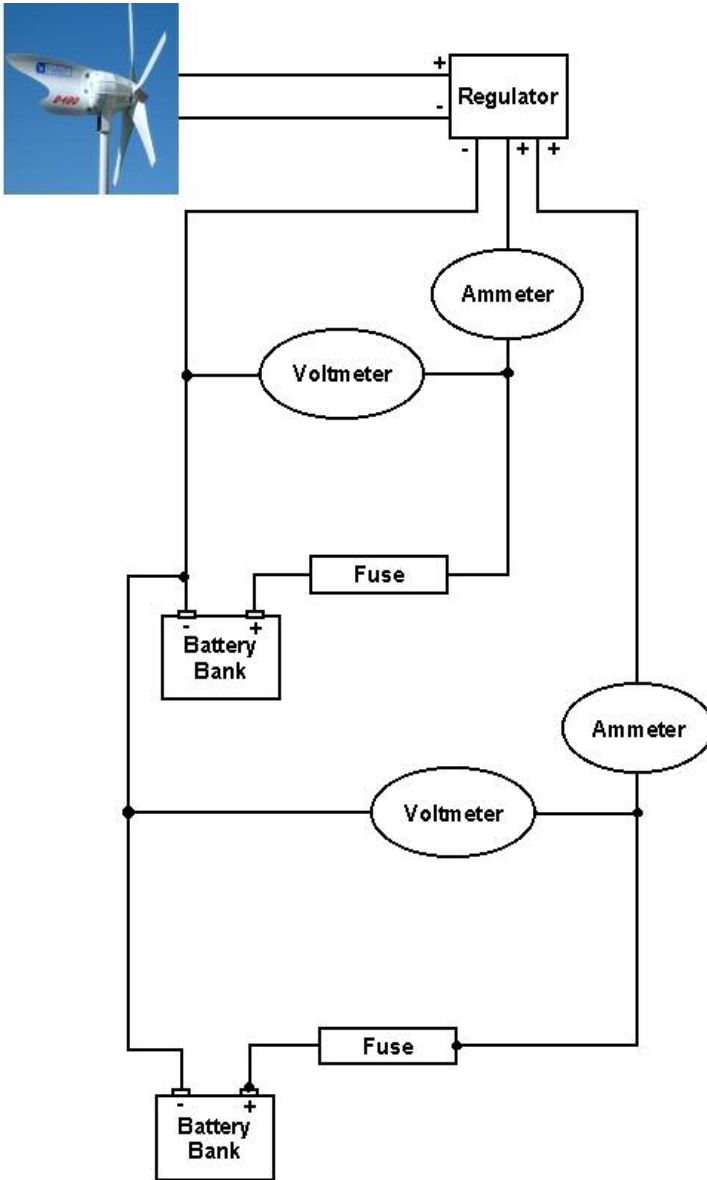

### Where a battery monitor is fitted

If your system is fitted with a digital battery monitor, a shunt will have been installed close to the batteries. One side of the shunt is connected directly to the battery terminal or busbar. All other connections are made to the opposite side of the shunt. The shunt is most usually connected in the negative line. When wiring the D400 to a system fitted with a shunt, observe polarity and connect the appropriate D400 output cable to the non-battery side of the shunt. Again observing polarity, the other D400 output cable should be made directly to the battery terminal or busbar. The D400's output will now pass through the shunt and the monitor will display a reading. If the shunt is bypassed by connecting both positive and negative output leads directly to the battery, the meter will fail to 'see' the D400, and register no output.

The D400 is fitted with 4.5 sq. mm. output cable. Use extension cable of at least this cross-section.

## Performance and expectations

The D400 is extremely efficient by design, making it the most powerful and productive wind generator of its rotor size currently available.

The D400 should perform in line with, or exceed, the values given in the output graph. When monitoring the system, it is important that wind speed measurements are taken at the same height as the turbine, and that the batteries are at least 40% discharged. Note also that if a regulator is installed as part of the system, dumped output will not be seen by shunt-sensed battery monitors.

Should outputs be below expectations, first suspect turbulence in the wind stream. Turbulence at a given site can be specific to a particular wind direction where it is caused by an obstruction either up or downwind of the turbine. When the wind direction changes, and the obstruction is no longer in line with the turbine, outputs may return to expected levels. The response in this instance might be to live with it if the turbulent wind direction were not the prevailing wind direction. Alternatively, the D400 could be re-sited or raised in height.

If poor output cannot be attributed to site conditions, re-check the whole installation against the wiring diagram and also look for poor or loose connections.

Finally, ensure that the batteries are in good condition.

If you still suspect a problem with the machine, consider the following:

- Have the air blades been fitted the right way round? The tapered holes in the blade roots should face forwards (see Assembly section) and the rotor should spin clockwise when the D400 is viewed from the front.
- Do the air blades spin freely? The air rotor should spin without any undue noise or friction. If not, is the stop switch in the 'brake' position, or could there be another short circuit in the output cables? (Make sure you disconnect the batteries before trying to find out!)
- Is the D400 free to move about its yaw axis? It should move easily with no undue noise or friction.

If in doubt, refer to your Dealer or the manufacturer.

Note that there is a short period of 'running in' with a new wind turbine. The bearings and shaft seals of a new machine take 40 – 50 hours of operation before mechanical friction falls to its design level. As a result, your D400 may seem a little slow to respond in light winds until this 'running in' period has passed.

## Routine Maintenance

The D400 is robustly engineered and should give years of trouble-free service.

Bearing life in normal windspeed conditions is expected to be in excess of 10 years. Shaft seals would benefit from replacement after five years.

The yaw bearing brushes should not require replacement during the life of the machine.

The alternator itself is hermetically sealed against moisture ingress.

Routine maintenance would consist of periodically examining the air blades for signs of damage. Blades exhibiting chips or nicks should be replaced.



[www.eclectic-energy.co.uk](http://www.eclectic-energy.co.uk)



## DECLARATION OF CONFORMITY

We declare that this product complies with the following standards/directives:  
89/336/EEC

Product description: D400 Alternator

Model number: EE400

Serial number:

Signed:

Eclectic Energy Limited

Edwinstowe House

High Street

Edwinstowe

Nottinghamshire

United Kingdom

NG21 9PR

+44 (0) 1623 821535

## GUARANTEE

The D400 Wind Generator is guaranteed against faulty parts and manufacture for a period of twelve months from date of purchase.

The unit should be returned prepaid to:

Eclectic Energy Ltd Edwinstowe House High Street Edwinstowe  
Nottinghamshire United Kingdom NG21 9PR

Damage caused by mishandling, faulty installation or accident is not covered. Eclectic Energy can not be liable for damage caused by the D400 in the event of accidental contact, incorrect installation or insufficient care.

However, Eclectic Energy Limited is committed to provide after sales care as fully and efficiently as possible in order to support our customers.

This guarantee does not affect your statutory rights.